

	<h1>CCV InSync</h1>	PA91P005 Rev.: 02 Page 1 / 16
Setup Manual		05/2020

CCV InSync



CCV InSync C



 	<h1>CCV InSync</h1>	PA91P005 Rev.: 02 Page 2 / 16
Setup Manual		05/2020

Glossary

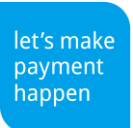
1	Purpose	3
2	Scope	3
3	Glossary	3
4	Startup	4
4.1	Startup via TS3.....	4
4.2	Startup via ZVT	9
4.3	Startup via MDB	11
4.4	Startup via O.P.I.	11
5	Standalone operation	12
5.1	Standalone configuration via TS3	12
5.2	Further information on the digital I/O ports	12
5.3	Connection aid I/O cable with open ends	12
5.4	Circuit example digital I/O	13
6	Logfile	14
7	Documents	16
8	FAQ	16

 	<h1>CCV InSync</h1>	PA91P005 Rev.: 02 Page 3 / 16
<h2>Setup Manual</h2>		05/2020

1 Purpose



Instruction to setup a CCV InSync Terminal with software version 59.xx. Successor versions may differ.

2 Scope

CCV Group, Integrators.

3 Glossary

- CCV InSync: 3in1 Payment Terminal
- TS3: Terminal Supervisor 3, Software to administrate the Terminals
- TID: Terminal-ID
- PU: Processing Unit
- Further terms and information: see system manual

 	<h1>CCV InSync</h1>	PA91P005 Rev.: 02 Page 4 / 16
<h2>Setup Manual</h2>		05/2020

4 Startup

You can put the CCV InSync Terminal into operation in the following ways.

4.1 Startup via TS3

Make sure your PC is connected to the CCV InSync via USB- or LAN-cable. Power up the CCV InSync. After boot up the display of the CCV InSync shows „**Inbetriebnahme erforderlich, Außer Betrieb**“ / „**Initiation required, Out of use**“. Start Terminal Supervisor 3 (TS3). You will need the licence level 3 or higher. Click in menu „**Connection**“ – „**New**“ and configure the connection as shown below. The description shows startup via USB.

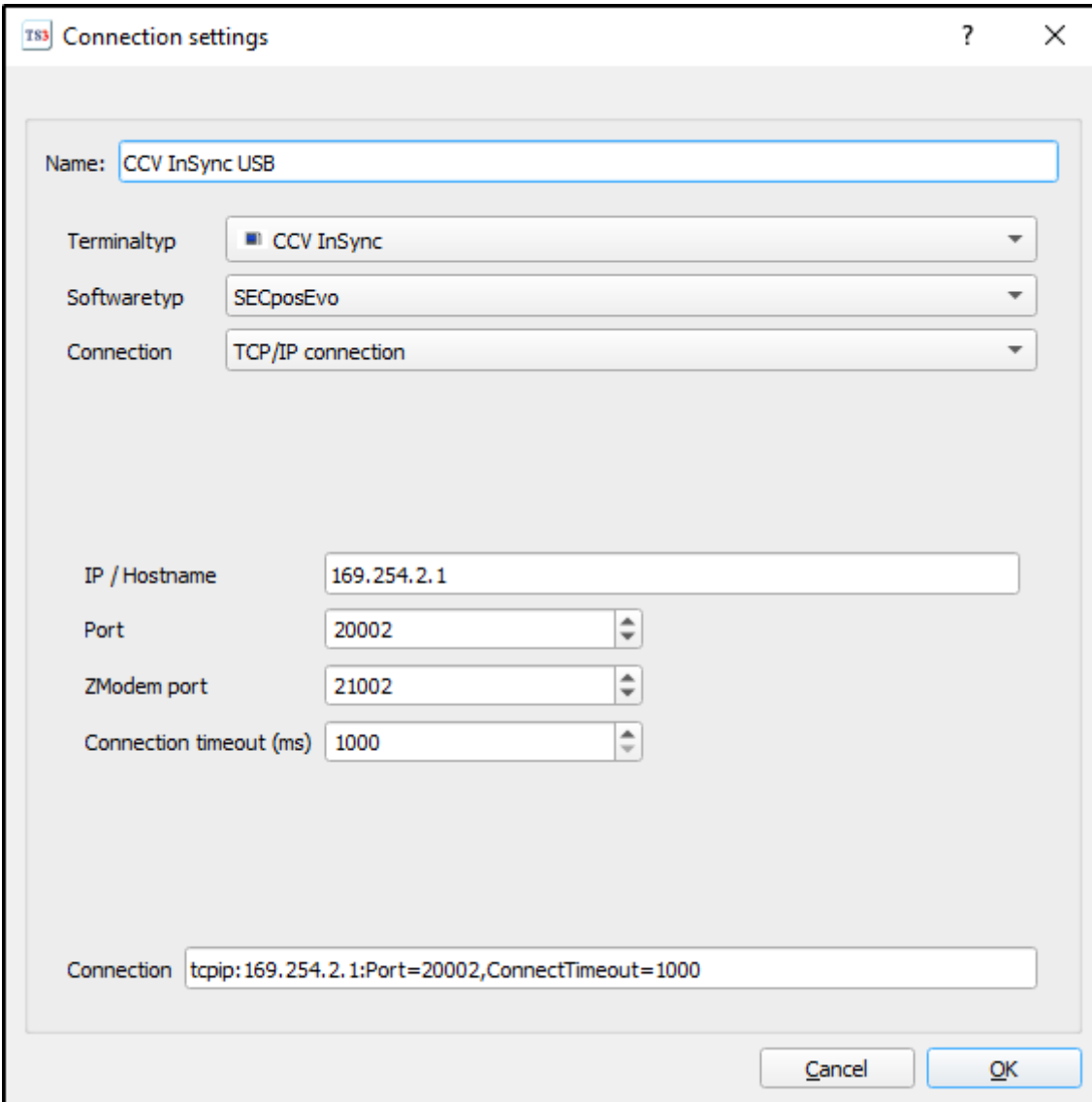

TS3 Connection settings

Name:

Terminaltyp:

Softwaretyp:

Connection:



IP / Hostname:

Port:

ZModem port:

Connection timeout (ms):

Connection:

 	<h1>CCV InSync</h1>	PA91P005 Rev.: 02 Page 5 / 16
<h2>Setup Manual</h2>		05/2020

Connect to the CCV InSync by double click on the connection. If the connection was successful the grey square changes from light green to dark green for 20 seconds (dark green = connection to CCV InSync is established).

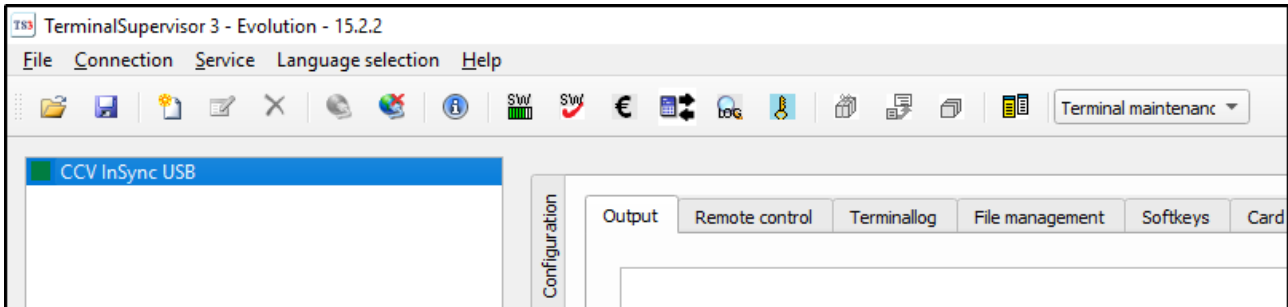

Note: At the same time some menu functions will be active. By click on  (Display terminal version) or at the menu bar „Service“ – „Version“ you will get information about the CCV InSync shown in the output tab.

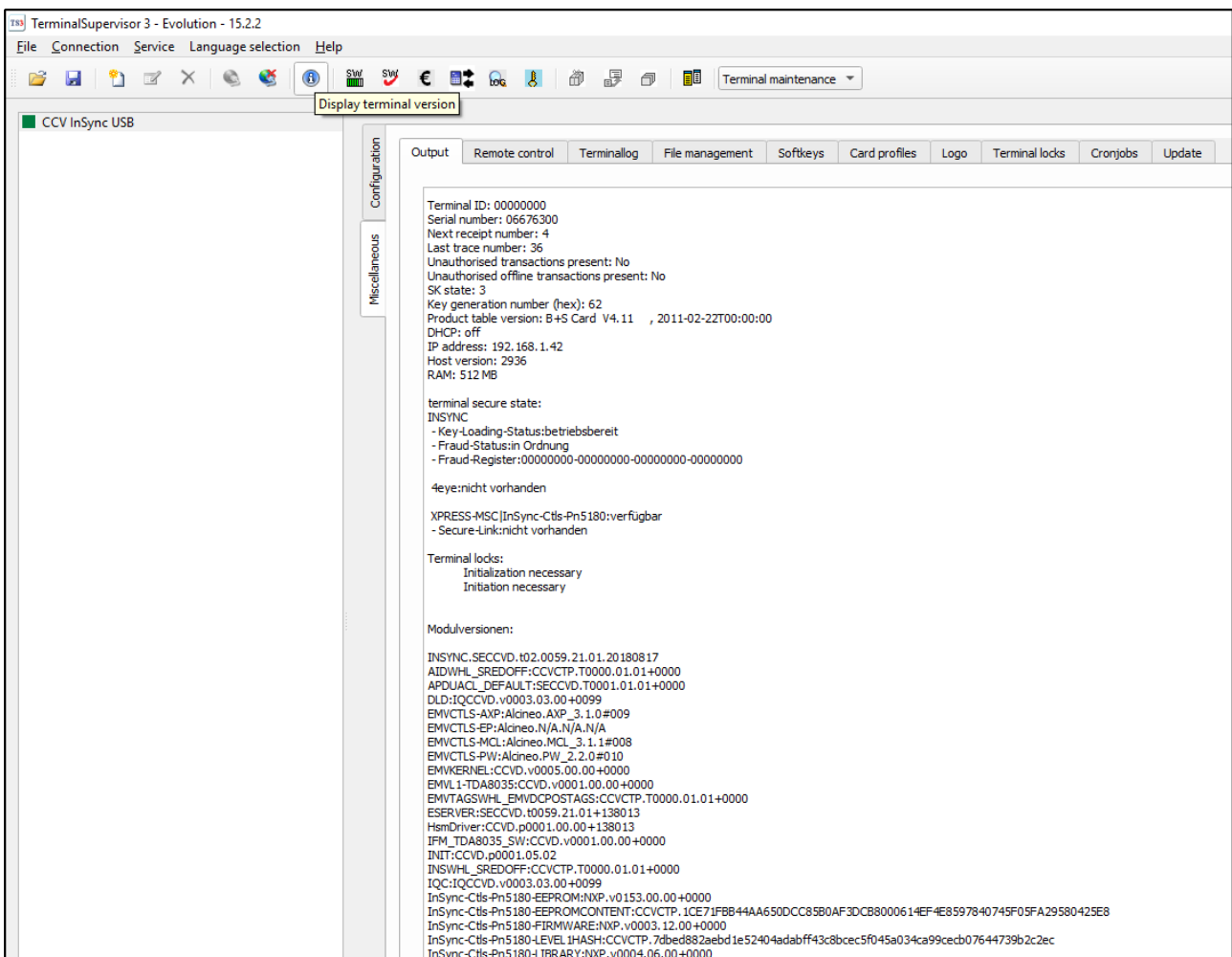

Click on tab „**Remote control**“ and „**Start**“. Then click on „**Service**“ und „**Initiation**“.

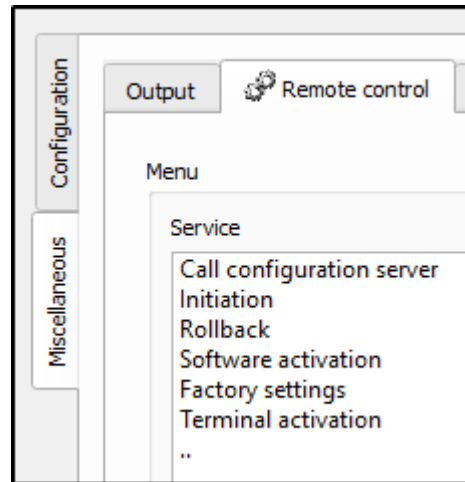
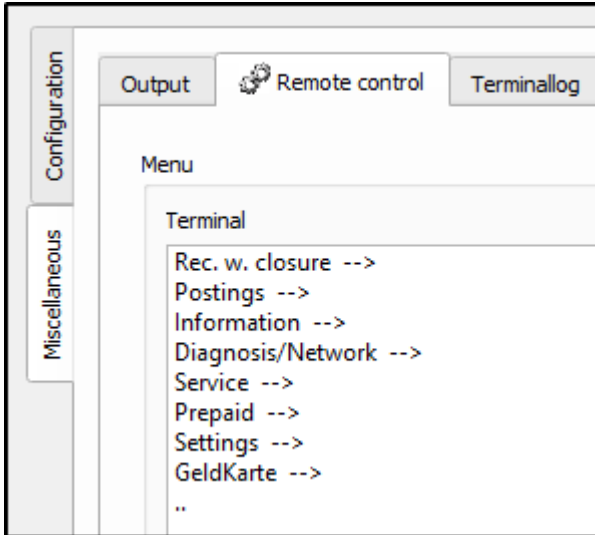

Choose the favored language, for example English.

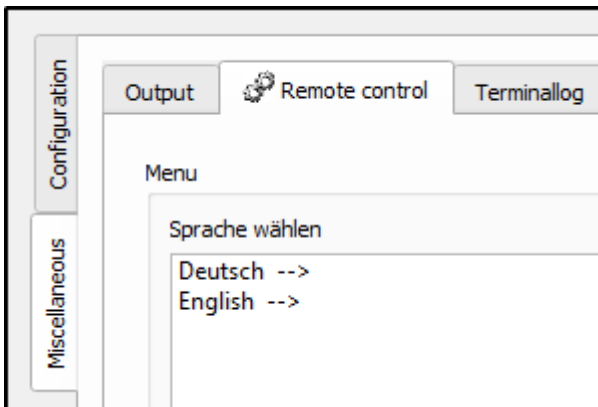

Type in the 8-digit TID. Repeat the entry of the TID. You will get the TID from your Network-provider.

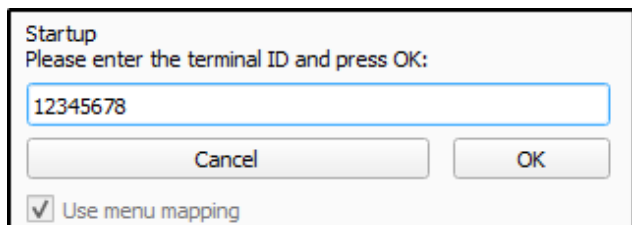
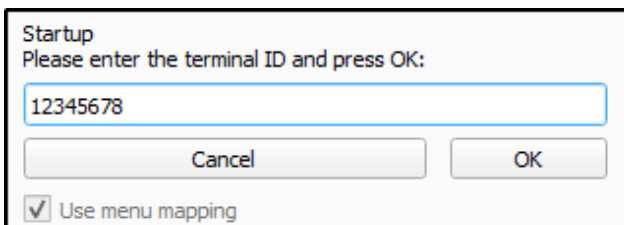

Choose the PU.

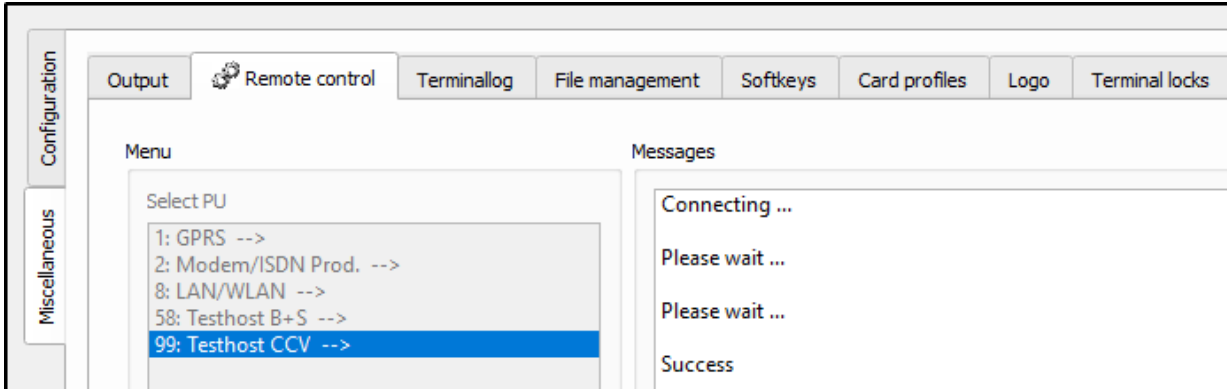

Choose DHCP or a static IP-address. Following you can choose if you like to setup cash register connections.

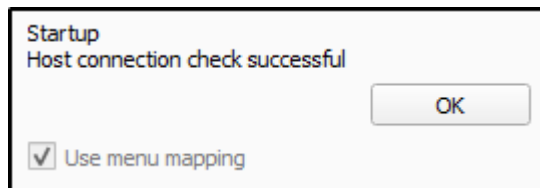
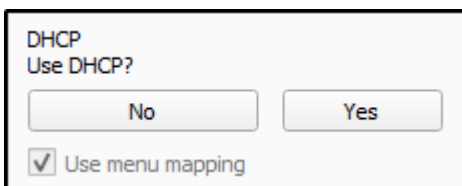

You can then choose whether a cash register connection should be activated.

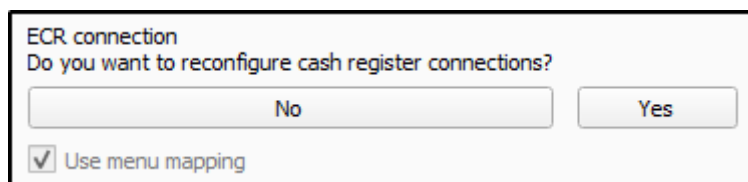

If you like to setup cash register connections you can choose between ZVT, MDB and O.P.I.. To finish ECR connection click on „..“ below „**OPI (serial)**“.

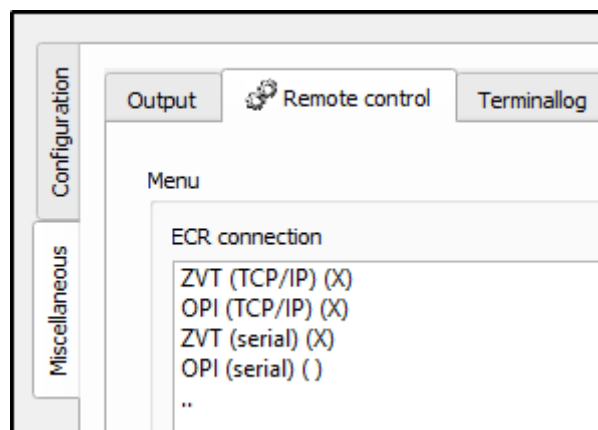

After successful initiation the OPx executes some diagnosis.

```

Receipts
**          Success          **
- EVALUATION VERSION -

  CCV Deutschland GmbH
    Setup
    CCV InSync

  Configuration diagnosis

13.09.2018                13:45
Terminal ID              12345678
TA-No.                  000046
Max. Offline bookings   5

**          Success          **
- EVALUATION VERSION -

  CCV Deutschland GmbH
    Setup
    CCV InSync

  EMU configuration diagnosis

13.09.2018                13:45
Terminal ID              12345678
TA-No.                  000047

  Terminal
=====
Terminal type           95
  
```

The display from CCV InSync shows „Terminal bereit“ / „Terminal ready“ and the upper left LED flashes green.

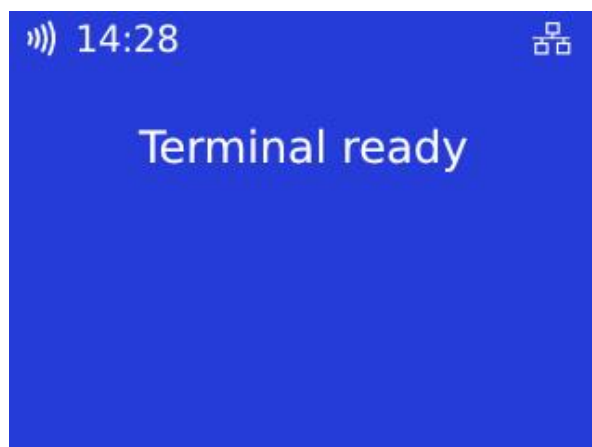

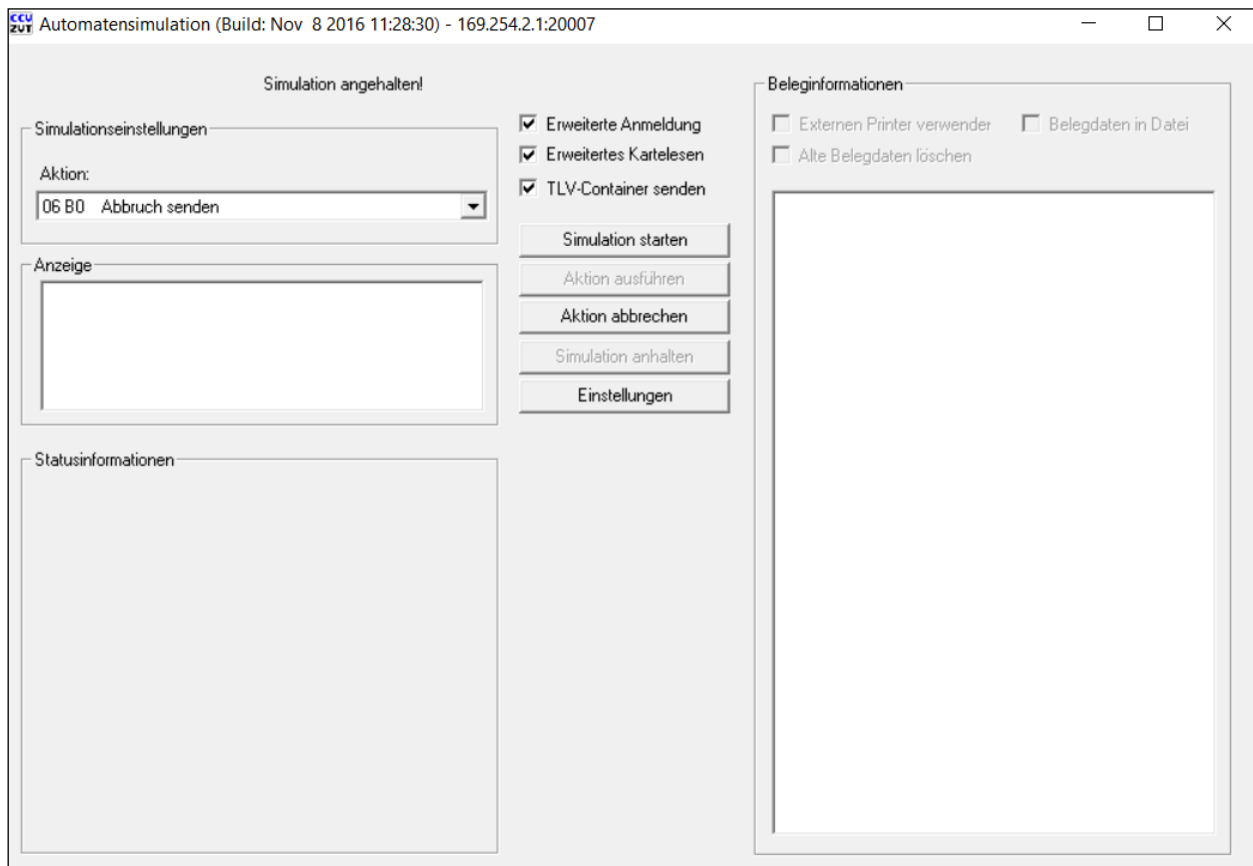

4.2 Startup via ZVT

Please start the CCV software tool „**ZVT-Automatensimulation**“. Alternatively you can send the ZVT commands to the CCV InSync with your application.

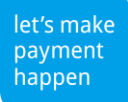

To configure the settings click on „**Einstellungen**“. To send a command to the CCV InSync click on „**Simulation starten**“, set the checkboxes as shown below and confirm with „**OK**“.

Select the command „**08 13 Konfiguration ändern**“ at the drop-down menu „**Aktion**“ and click on „**Aktion ausführen**“.

 	<h1>CCV InSync</h1>	PA91P005 Rev.: 02 Page 11 / 16
Setup Manual		05/2020

Type in the 8-digit TID, the PU and IP-address or select DHCP and confirm with „OK“.

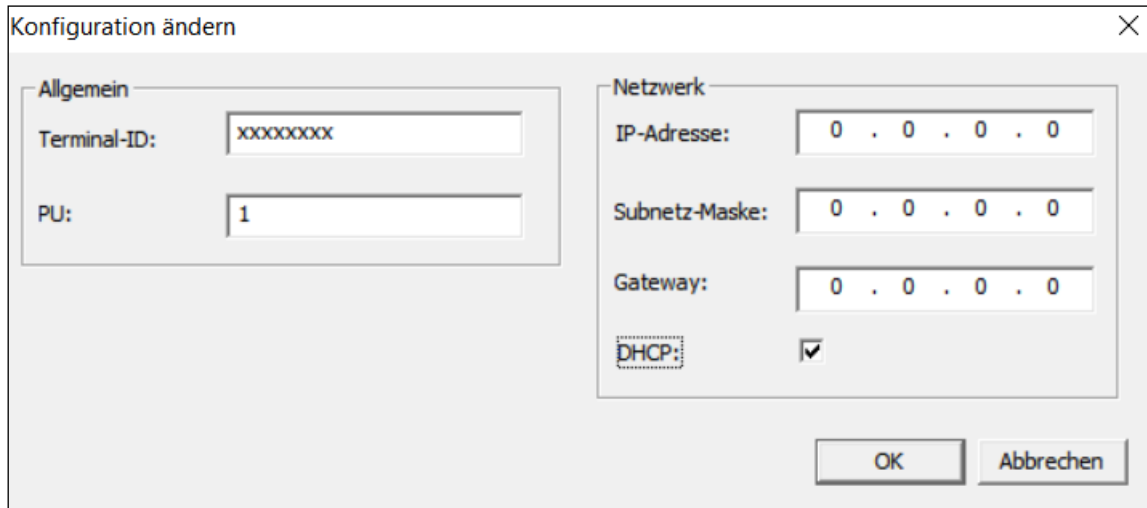

Please select the command „**06 93 Initialisierung**“ at the drop-down menu „**Aktion**“ and click on „**Aktion ausführen**“. If it was successfully operated it will show „**Initialisierung erfolgreich**“ at „**Statusinformationen**“.

At last select the command „**06 70 Diagnose**“ at the drop-down menu „**Aktion**“, select the „**Diagnose-Typ**“ „**EMV-Diagnose**“ at the drop-down menu and confirm with „**OK**“.

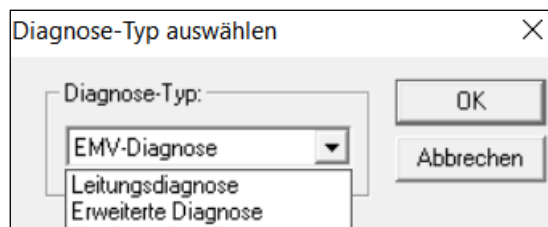

Now „**Statusinformationen**“ shows „**Diagnose erfolgreich**“ and the CCV InSync shows „**Terminal bereit**“ / „**Terminal ready**“.

You can check the configuration (for example: TID, own IP, Host-IP) with command „**06 1A Konfiguration drucken**“.

4.3 Startup via MDB

You can use MDB commands for startup and find relevant commands here:

https://download.ccv-deutschland.de/allgemein/OPP/OPP-C60/Dokumentation/OPP-C60_MDB_ManufacturerSpecificExtension_Configuration.pdf

4.4 Startup via O.P.I.

It is not possible to execute an initiation via O.P.I.. Please initialize the CCV InSync via TS3, ZVT or MDB as described.

5 Standalone operation

Utilizing the DigOut pin the CCV InSync can be operated in a standalone mode without the need of being connected to an ECR. In this configuration no impulse to release the product or service is being emitted, but one impulse per unit payed (e.g. 5 units of 50 cents each = 2,50 euros = 5 impulses to the VMC). Thus a coin insertion is simulated.

5.1 Standalone configuration via TS3

Via the menu item “Common Settings” -> “Application settings” -> “InSync-standalone application” -> “Activate InSync-standalone application” the standalone mode can be activated. Furthermore, the base amount, the maximum amount and the operator timeout can be configured.

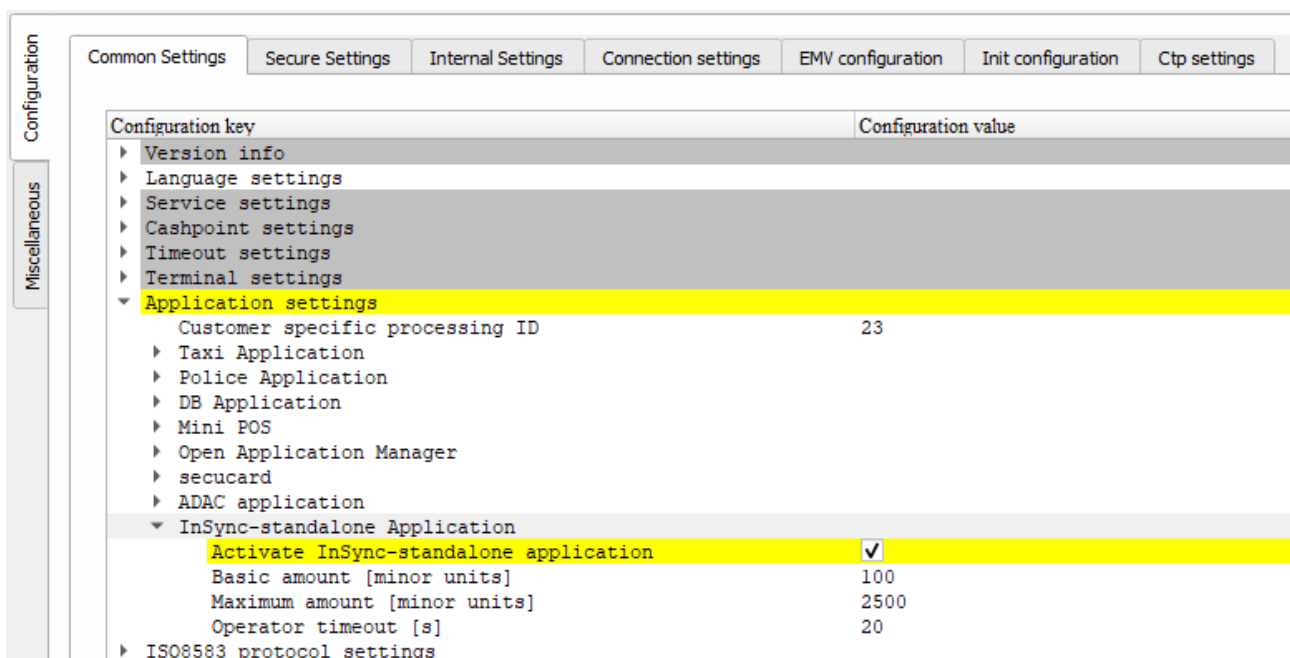

5.2 Further information on the digital I/O ports

Via the inputs DigIn1 – DigIn3 the capacitive buttons for “Abort”, “Plus” and “ok” can be operated externally with the help of push buttons. If the cancel button remains switched on for a longer period of time, an empty coin return is assumed and the device switches to an “out of order” state. This is achieved by means of a normally open contact, which switches the respective input to ground.

Pulse length: The signals are omitted alternately with 100ms signal, 100ms pause.

Note: In a future version of SECpos EVO the interval lengths will be individually adjustable.

5.3 Connection aid I/O cable with open ends

I/O cable article number 03134-91

The cable assignment is to be taken from the drawing number PA00K046.

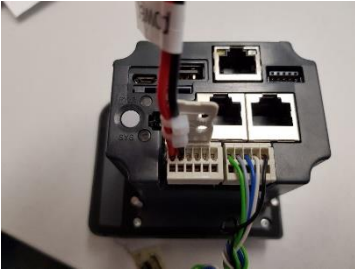

PIN	6	5	4	3	2	1	5	4	3	2	1
Bild	rot	schwarz	n/a	n/a	n/a	n/a	grün	grau	blau	weiß	schwarz
Belegung	+ 12V	GND					DigOut 1	DigIn 1	DigIn 2	DigIn 3	GND
I/O Kabel	rot	schwarz					braun	gelb	grün	blau	rot

5.4 Circuit example digital I/O

DigOut1 is a so called “open collector” circuit. This is used to switch the ground on an impulse. This can then be used to control a relay, for example.

Note: It should be noted that in the circuit example, due to the inertia of a relay, it is not possible to display the output of several impulses via the relay. However, it illustrates the electrical circuitry and the operating principle.

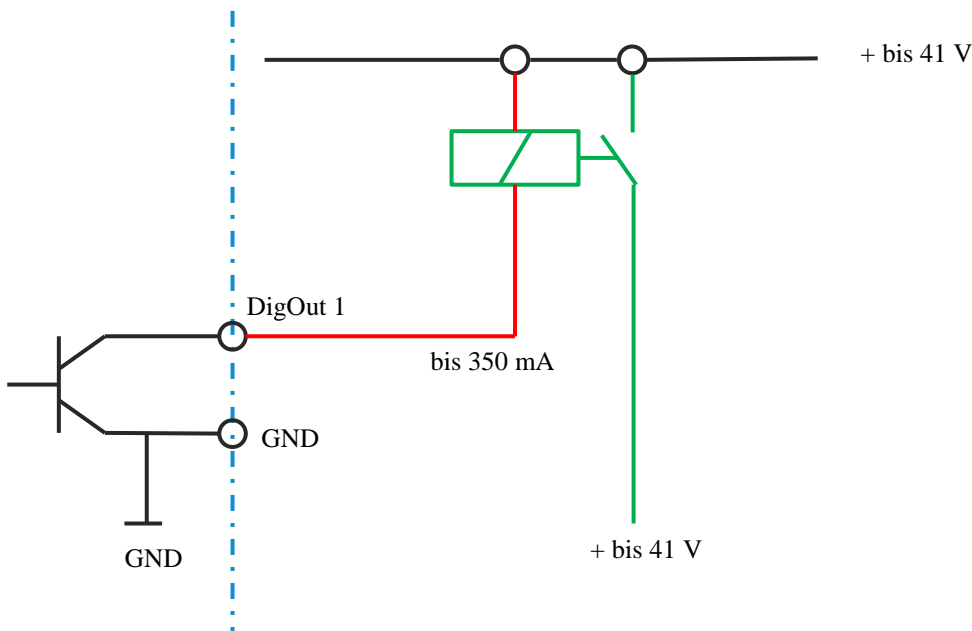

Circuit example for the connection of three external buttons with identical functionality as the InSync's integrated capacitive buttons (Abort, plus, ok).

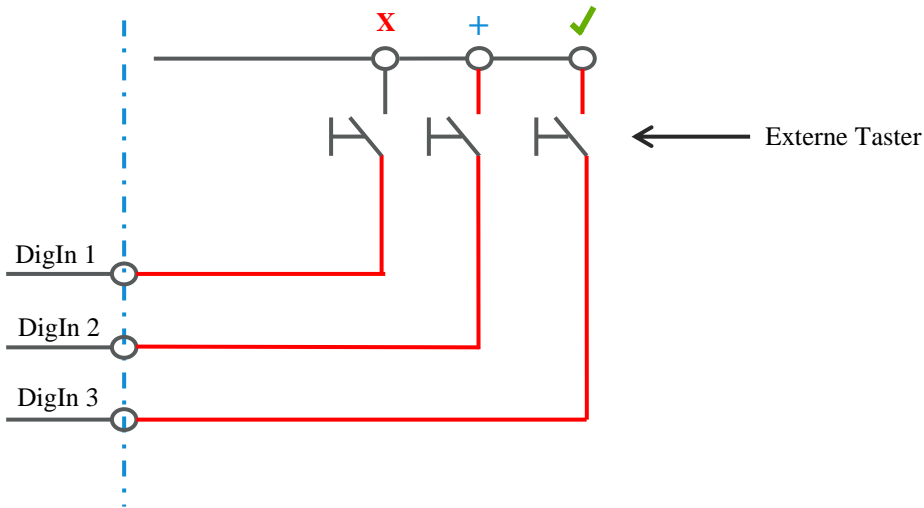

6 Logfile

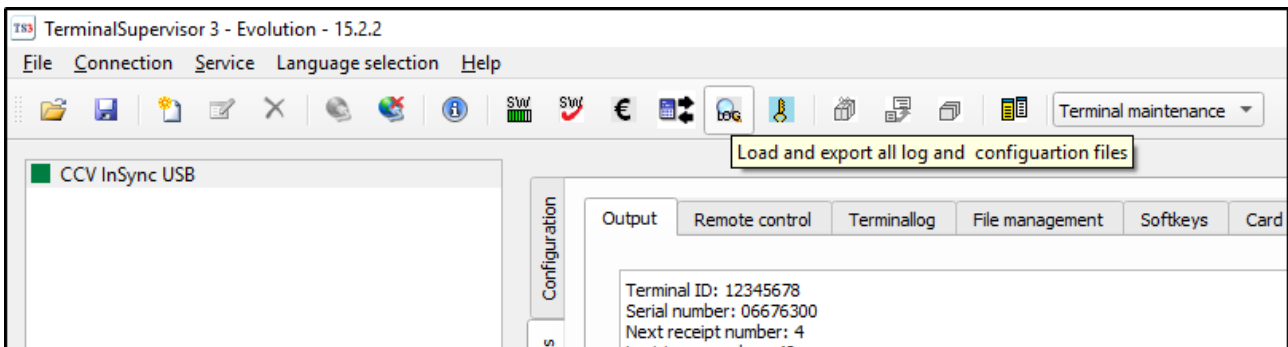

To have a short documentation about the executed setup process you can create a logfile via TS3 by performing the following steps. This file will also help for diagnosis and support.

Doubleclick on „**CCV InSync USB**“ (or similar description) to connect to the CCV InSync. Click on symbol „**Load and export all log and configuration files**“.



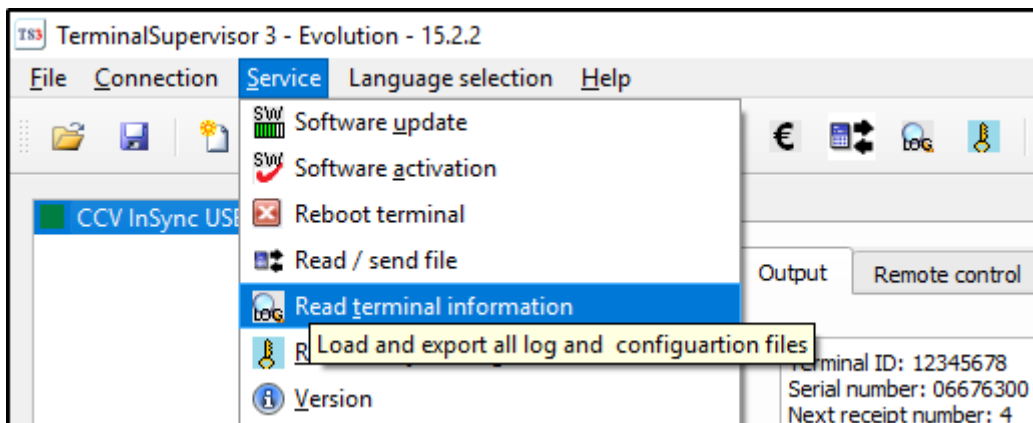

Alternatively you can click on the tab „**Service**“ and „**Read terminal information**“.

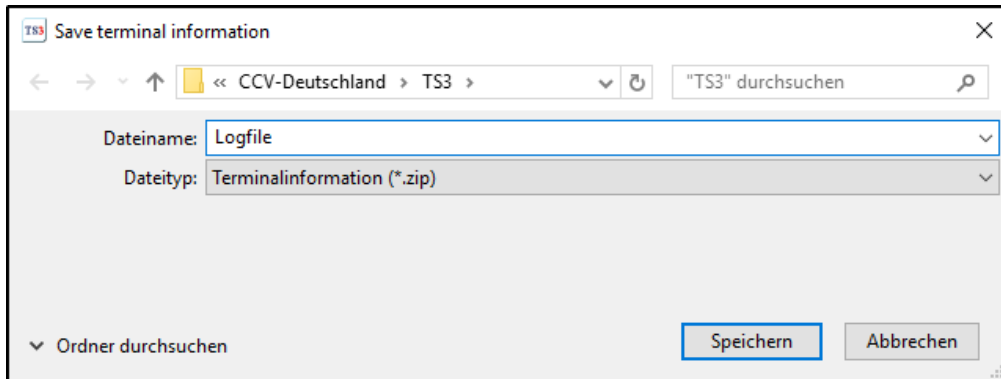

 	<h1>CCV InSync</h1>	PA91P005 Rev.: 02 Page 15 / 16
Setup Manual		05/2020

Name the logfile, choose a location to store and confirm with „**Save**“.



 	<h1>CCV InSync</h1>	PA91P005 Rev.: 02 Page 16 / 16
Setup Manual		05/2020

7 Documents

- System manual: https://download.ccv-deutschland.de/allgemein/CCV_InSync/Dokumentation
- CCV InSync: <https://www.ccv.eu/de-de/partner-integratoren-netzbetreiber/unbediente-bezahlloesungen/ccv-insync>

8 FAQ

- **How can I get in touch with CCV Hotline?**
<https://www.ccv.eu/de-de/partner-integratoren-netzbetreiber/service-und-support>
- **What is the website from CCV Deutschland?**
<https://www.ccv.eu/de-de>
- **Where can I get the Terminal-ID (TID) from?**
You will get it from your network-provider.
- **What is a PU?**
Processing Unit (host-set connection configuration).
- **What protocols are available with CCV InSync?**
ZVT (serial/IP), O.P.I. (IP, serial is not supported), MDB (serial).
- **Where can I get the installation files for Terminal Supervisor 3 (TS3)?**
https://download.ccv-deutschland.de/allgemein/Terminal_Supervisor/TS3
(you will get the username and password for protected download area from your contact at CCV Deutschland)
- **Where can I get installation files for ZVT-Automatensimulation?**
https://download.ccv-deutschland.de/allgemein/Tools_allgemein/ZVT-Automatensimulation
(you will get the username and password for protected download area from your contact at CCV Deutschland)
- **Where can I get installation files for xPay (O.P.I.)?**
https://download.ccv-deutschland.de/allgemein/Tools_allgemein/xPay
(you will get the username and password for protected download area from your contact at CCV Deutschland)
- **Where can I find data sheets?**
System manual: https://download.ccv-deutschland.de/allgemein/CCV_InSync/Dokumentation
CCV InSync: <https://www.ccv.eu/de-de/partner-integratoren-netzbetreiber/unbediente-bezahlloesungen/ccv-insync>